

**BALT**<sup>®</sup>

# HRTABLE

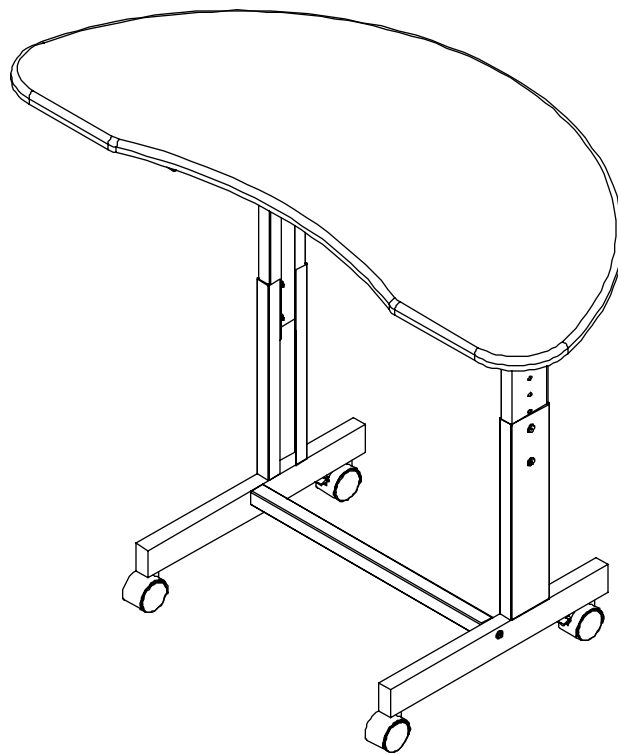









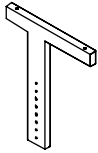

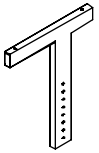

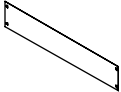
Adjustable Table/ Laptop Desk

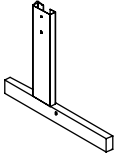

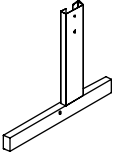
## Assembly Instructions

# HRTABLE

## Adjustable Table / Laptop Desk

Part	Drawing	Description	Qty	Part	Drawing	Description	Qty
P1		Top Panel	1 EA	<b>Hardware List</b>			
P2		Right Upper Insert	1 EA	A		9/16" Socket Screw	8 EA
P3		Left Upper Insert	1 EA	A1		1-1/2" Socket Screw	2 EA
P4		Stability Panel	1 EA	A2		2-1/2" Socket Screw	4 EA
P5		Right Leg Receiver	1 EA	C		Square Nut	4 EA
P6		Left Leg Receiver	1 EA	D		2" Locking Caster	2 EA
P7		Crossbrace	1 EA	E		2" Caster	2 EA
				F		Allen Wrench	1 EA
				G		Caster Wrench	1 EA

Do not use unless all screws are tight. At least every six months, check all screws to be sure they are tight. If parts are missing, broken, damaged, or worn, stop use of the product until repairs are made by your dealer using factory authorized parts.

***Should you require assistance during assembly,  
please call our Customer Service Department  
Monday - Friday 8 a.m. - 5 p.m. Central Standard Time  
Toll-Free Customer Service  
1-800-749-2258***

# HRTABLE

## Assembly Diagram



1. Identify and Separate all the Parts and Hardware.
2. Place the Top panel (P1) with the insert nuts facing up. Attach Right Upper Insert (P2) and Left Upper Insert (P3) using 4 each (A2) screws. **(Finger tighten only)**
3. Attach Stability Panel (P4) to Left & Right Upper Inserts (P3 & P2) using 4 (A) Screws as shown in illustration #2. **(Tighten all the screws at this time)**

Illustration # 1

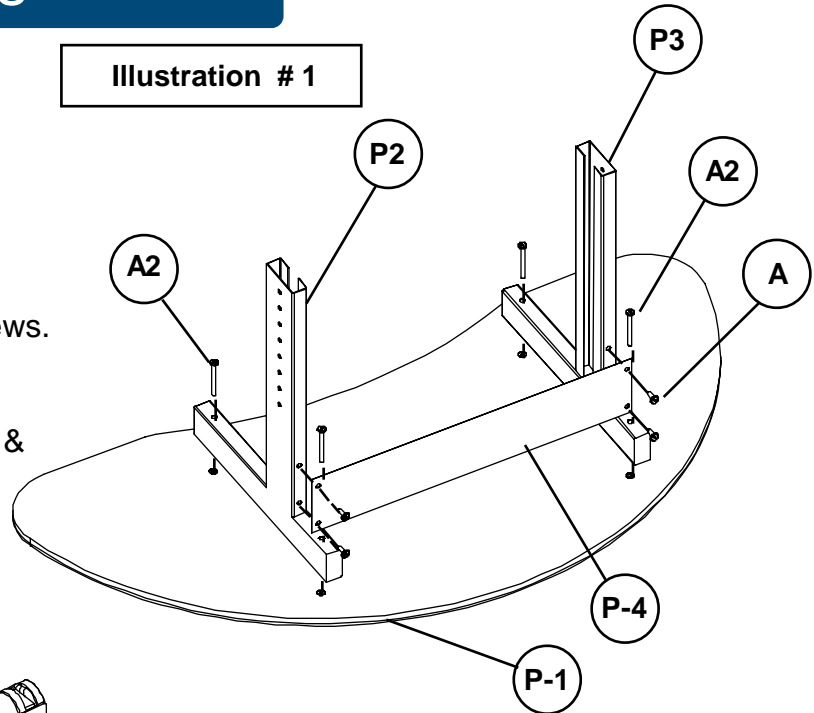
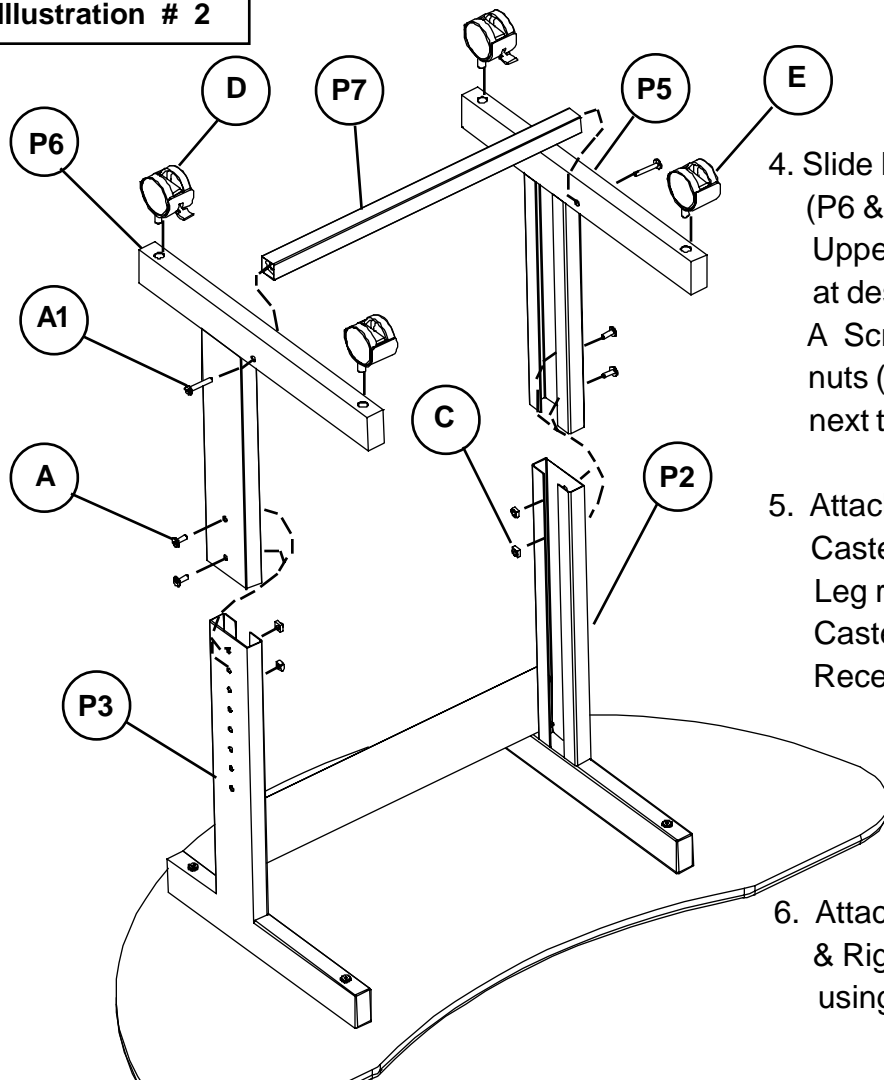

Illustration # 2



4. Slide Left & Right Leg Receivers (P6 & P5) over Left and Right Upper Insert (P3 & P2). Secure at desired height using (4) each A Screws and (4) each C Square nuts (flat side of the nut should be next to the metal).
5. Attach (2) each D Locking Casters to the front of the 2 each Leg receivers and (2) each E Casters to the back of the Leg Receivers.
6. Attach Crossbrace (P7) to Left & Right Leg Receivers (P6 & P5) using 2 (A1) Screws.